

## PATIENT LIFT : BLUE FLYER PLUS with mechanical opening legs



MADE FROM STEEL  
WEIGHT CAPACITY : 180 kg  
CLASS 1 MEDICAL DEVICE

CONFORM TO STANDARD NF EN ISO 10535 : 2007

# Contents

## User Manual / Patient Lift: BLUE FLYER PLUS with mechanical opening legs

• Intended Purpose Scope of Delivery .....	1
• Assembling Instructions .....	2-3
• Patient Lifts Use .....	4-7
• Motorisation Informations .....	8-9
• Slings Use .....	10-13
• Reuse Labelling .....	13-15
• Preventive Maintenance & Security Controls .....	16-17
• General Safety Guidelines .....	18
• Technicals & Dimensionals Characteristics .....	19
• Spare Parts .....	20
• Cleaning & Maintenance .....	21
• Motorisation Technicals Characteristics .....	22-23
• Troubleshooting Guide .....	24
• Warranty .....	25



# Intended Purpose

The patient lift BLUE FLYER PLUS with mechanical opening legs) is an active Class I medical product according to EU Council Directive 93/42/EC, Appendix IX. It can be universally used in the entire care sector (except potentially explosive areas).

Its use compensates for the disability or incapacity of the patient and makes the working conditions easier for the care personnel.

It is provided exclusively for transfer and transport of a patient with restricted mobility caused by illness or disability.

Moving the patient lift BLUE FLYER PLUS with mechanical opening legs) is only suitable for short distances inside the residence / sphere of activity of the patient and on one building level. It is only permitted to be used on a flat and level surface.

It is intended for short-time use without contact with injured skin and needs a suitable hoist sling for use.

The patient is picked up in sitting position as standard; however a lying position is also possible when an Nausicaa lying transport clamp and lying transport sling are used. Even picking up a patient from the floor is possible.

The Flyer plus with mechanical opening legs is suitable for a patient weight up to maximum 180 kg.

The operation is performed by an instructed carer.

The BLUE FLYER PLUS with mechanical opening legs is suitable for use at an ambient temperature from 0 °C to 40 °C, humidity of 20% to 80% and air pressure of 700 hPa to 1060 hPa in normally composed atmospheric air. It may be used in humid rooms such as bathrooms and toilets. Do not use this hoist under a running shower.

Syndromes such as osteogenesis imperfecta, osteoporosis or spinal column damage and mental aberration or epileptic attacks can be contraindications. The BLUE FLYER PLUS with mechanical opening legs is only permitted to be used after careful consideration of the individual patient by the doctor and the care personnel.

## Scope of Delivery

The Patient lift has already been inspected at the factory to ensure that it is free from defects and that nothing is missing. Nevertheless, please check the product immediately after receipt for any damage which may have occurred during transport.

Use the delivery note to check that all items are present and that the delivery is thus complete.

Box	Contents	Units
BLUE FLYER PLUS with mechanical opening legs	BLUE FLYER PLUS with mechanical opening legs	1
	Battery pack (removable)	1
	Handcontrol	1
	User Manual	1

# Assembling Instructions

BEFORE USING YOUR PATIENT LIFT, IT IS NECESSARY TO CHECK :

- The wheels turn and roll normally.
- The rear wheels function correctly.
- There is no wear or deformation on the hooks.

**WARNING :**

- To preserve the inserts, do not overtighten.
- Assembly is done with the brakes locked.

This is how your product is packaged once out of the box.

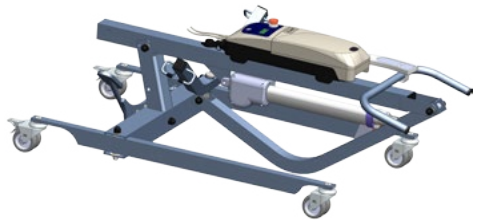

**Step 1 :**

- Rise the mast of the device.



**Step 2 :**

This step must be done on both sides of the mast.

- Screw the long axis on the mast.
- Insert the 3 mm plastic washer
- Insert the 2 mm standard steel washer
- Insert the M10 nut
- Insert the caps

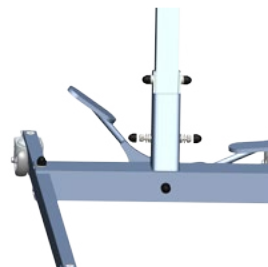

# Assembling Instructions

## Step 3 :

- Fix the actuator on the lifting arm.
- Insert the two 1 mm plastic washers on each side of the actuator.
- Insert the M10 x 45 mm screw
- Insert the M10 nut
- Insert the caps

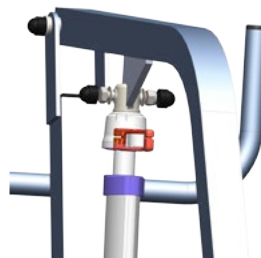

- Your device is ready for use.



## DIRECTIONS FOR USE :

- Your patient lift is designed to lift people, do not use it for other purposes.
- Check that the patient's weight does not exceed the maximum weight that can be raised by the patient lift.
- Do not force the controls and features of the patient lift, they are all easy to use and do not require strength.
- Operate the patient lift by pushing the handles, never by pushing the patient.
- The patient lift must be handled with care when a patient is transferred and at a speed appropriate to the situation.
- Operate the patient lift on flat and smooth surfaces. It is not recommended to be used on a slope of more than 5°. If you are forced to move on a ramp, it is recommended that a second person helps you. Do not use an electric patient lift in a shower.
- Do not recharge the batteries near a bath or shower.

# Patient Lifts Use

Patient lifts allow patients to be transferred from a bed, chair, toilet, wheelchair or from the floor in an easy and efficient way.

In care environments, they offer to the caregiver the most appropriate solution for the basic tasks of patient handling: lifting and repositioning.

## TRANSFERT FROM A CHAIR



## TRANSFERT FROM A BED



# Patient Lifts Use

The mobile lifts are useful and efficient when a patient is dependent and therefore needs a caregiver to perform basic care.

Choosing the right device is essential as it has been demonstrated that the use of adapted equipment reduces the risk of injury, both for the patient and for the caregiver.

Using a patient lift requires a physical capacity assessment of the patient.

With our devices, caregivers can perform the following transfers:

- Patient transfer from a chair to a bed.
- Patient transfer from a bed to a chair.
- Patient transfer from the floor.



## Parking brake

The parking brakes are one of the important safety elements of an stand-up lift. The rear castors are fitted with parking brakes which act directly on the wheels. To lock the castors, press the parking lever to the stop using your foot (Castor Locked). The stand-up lift can no longer be pushed in this setting. To release the castors, press the parking lever pointing upwards (Castor Released).

When locking the castors always insure that both castors are locked.  
If only one castor is locked on a sloping floor, the unlocked wheel will roll downhill around the locked wheel.  
Depending on the slope of the surface, there is the danger that the stand-up lift will tip over sideways.

Castor Released



Castor Locked



# Patient Lifts Use

1. If the patient is lying on his back, turn him so that he is facing away from you.
2. Fold the Nausicaa standard sling in half in the longitudinal direction.
3. Place the Nausicaa standard sling with the folded side on the back of the patient. In doing so, the Nausicaa logo and the labels must face downwards. Ensure that the bottom edge of the sling back part is on the coccyx and the top edge is on the shoulders of the patient.
4. Now roll the patient over the Nausicaa standard sling to the other side.
5. Now pull the folded half of the Nausicaa standard sling under the patient and place it properly.
6. Now turn the patient back onto his back.
7. The patient is lying correctly on the Nausicaa standard sling if his back is completely on the sling back part and the leg supports are next to the thighs.
8. Now raise the back part of the homecare bed until the patient is almost sitting upright.
9. Fold both the leg supports from the outside to the inside around the respective thighs of the patient.
10. Position your Nausicaa patient hoist with the Nausicaa standard transport clamp so that the Nausicaa standard transport clamp is at eye height in front of the patient. Ensure there is sufficient clearance between the face of the patient and the Nausicaa standard transport clamp.
11. Ensure before attaching to the clamp that both the shoulder loops as well as both the leg loops are at the same height.
12. Now hang both the shoulder loops in the outer hooks of the Nausicaa standard transport clamp.
13. Afterwards, hang both the leg loops crosswise on the inner hooks.
14. Raise the lifting arm of the Nausicaa patient hoist slightly until the leg and shoulder loops are tensioned. Now check whether the Nausicaa standard sling is attached correctly and comfortably.
15. You can now lift the patient. Use the manoeuvring handle located on the top edge of the sling back part for easier manoeuvring.





# Patient Lifts Use

Observe the following safety instructions before every lifting / uprighting and conveying of the patient:

- The care personnel (user) must have the corresponding expert knowledge to select and use a suitable hoist sling.
- Check the permissibility of the combination of transport clamp and hoist sling based on Chapter 10 Accessories / Combinations before using the patient hoist.
- Verify the actual maximum load of the combination. In the case of differences between the maximum loads of patient hoist, transport clamp and sling, the lowest maximum load is always mandatory for you.
- Check the correct sling size and sling form in relation to the patient.
- Check the safe condition of the sling before every use. The sling must have neither tears in the material nor damaged seams.
- Check whether the correct loop combination has been attached. All loops have 3 different mounting levels: long - medium - short. Each loop pair (e.g. leg loops, shoulder loops) must only show the following mounting combination: long – long, medium – medium or short – short.
- Check whether all loops are attached in the mounting hook.
- Lock the rollers/castors/wheels of the wheelchair, the homecare bed, the stretcher etc. in order to be able to raise and lower the patient safely. In doing so, leave the castors of the patient hoist unbraked.
- Arrange the patient transport to be as short as possible and never leave the patient hanging unsupervised in the hoist sling.
- Observe the patient during the transfer. Violent movements of the patient or holding on to objects during the transfer can result in hazards.
- Only lift the patient as high as is necessary.
- Keep the hoist slings away from intense heat or open flame; they are not flame retardant.

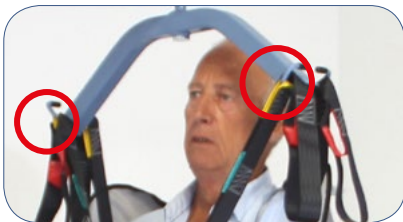

Prior to each use, it is important to check the status of the device: seams, state of the straps and of the fabric.

Any damage will either be repaired by NAUSICAA Medical, or will result in a disposal.

# Motorisation Informations



Before use, check that the actuator and the hand-control are correctly connected to the control unit (page 22)

Check the status of the control box and the battery

1



Check that the actuator is properly secured

2

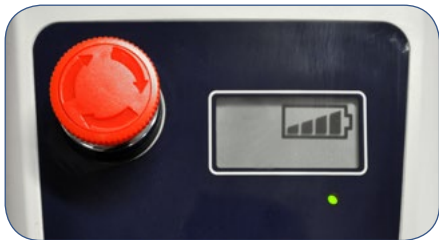

Check that the battery is charged



# Motorisation Informations

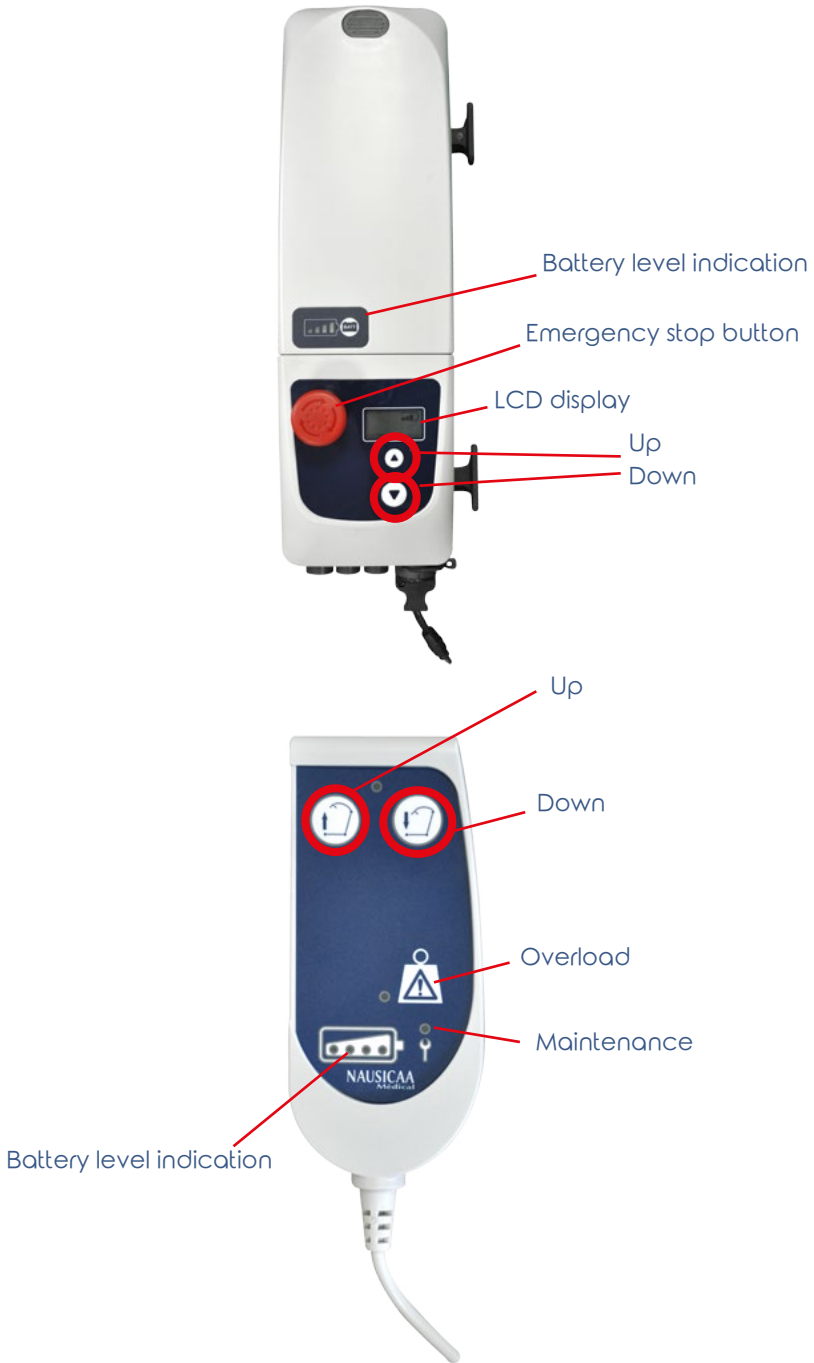

# Slings Use

---

An assessment of the patient capacity is required before using a patient lift and more precisely the following parameters should be taken into account depending on the situation, such as the patient's physical handicap, pathology and morphology.

In order to choose the right sling, the caregiver shall take into account the three following factors:

- Patient height
- Patient waist size
- Patient thighs size

All our slings are Class 1 Medical Devices, provide sustainable solutions for reassuring transfers and are compatible with all patient lifts with a 2-point or 4-point spreader bar.

## FABRICS

Depending on the slings model, we propose two types of fabric in polyester:

- Jersey: very easy to handle, provides an optimized and comfortable positioning.
- Net: ideal for bath and toilet, avoids maceration and easy to dry.

JERSEY



NET

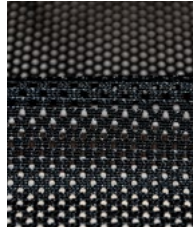

---

## IMPORTANT RECOMMANDATIONS

In order to get a maximum efficiency of these sort of product, it is necessary :

- to choose the appropriate size for the patient
- to get the best possible adjustment to the patient

These products must not be in direct contact with a wounded skin.

Read the instructions for use before using the sling.

Hang to the spreader bar the loop which are at the same level.

Do not change any adjustment while the patient is hanging in the sling.

Before lifting a patient, ensure that the sling is correctly hooked on the spreader bar.

# Slings Use

## Sling positioning

Check that loops are symmetrically attached to the shoulders and the legs



Seated position:  
- Short ties at the shoulders level  
- Long ties, crossed between the legs



Seated position:  
- Medium ties at the shoulders level  
- Long ties at the shoulders level



Half-seated position:  
- Medium ties at the shoulders level  
- Long ties, uncrossed between the legs

For lying down transfers or lifting from the floor transfers, it is necessary to always use a sling with a headrest or to add a removable headrest to the sling.

For patients without head support, it is necessary to always use a sling with a headrest or to add a removable headrest to the sling.

### CAUTION

Check that loops never slide off the hooks and check the make sure that the device (seams, state of the straps and of the fabric) is not damaged.

Check that the patient can not bump into something

Check that the combination sling / patient lifter maintains a good stability during the transfer



**THIS MEDICAL DEVICE MUST BE SET UP BY A PROFESSIONAL OR THE USER MUST BE EDUCATED TO SET IT UP.**

# Slings Use

The type and size of the belt always depends on the patient's stature and the type of application. NAUSICAA Médical offers you a wide assortment of lifting straps adapted to your requirements.

Patient's physical conditions	Types of transfers	Bed/chair transfer in a seated position	Transfer with the sling placed on the chair	Lifting from floor transfer	Bath, shower and pool transfer	Toilet and daily change transfer
Simple amputee (short/long)		<ul style="list-style-type: none"> <li>• Comfort sling</li> <li>• Fast adjustable comfort sling (without headrest) - for 2-point spreader bar</li> <li>• Universal eco sling (comfort)</li> </ul>	<ul style="list-style-type: none"> <li>• Standard comfort hammock</li> <li>• Universal eco hammock</li> </ul>	<ul style="list-style-type: none"> <li>• Comfort sling (+ headrest)</li> <li>• Comfort hammock without crossing (+ headrest)</li> <li>• Universal eco hammock</li> </ul>	<ul style="list-style-type: none"> <li>• Bath sling</li> <li>• Fast adjustable bath sling (without headrest) - for 2-point spreader bar</li> <li>• Fast adjustable eco sling (without headrest) - for 2-point spreader bar</li> <li>• Universal eco sling (bath)</li> </ul>	<ul style="list-style-type: none"> <li>• Quick toilet sling</li> <li>• Backrest toilet sling</li> <li>• Universal eco toilet sling</li> </ul>
Double amputee (short/long)		<ul style="list-style-type: none"> <li>• Comfort hammock without crossing</li> <li>• Standard comfort hammock</li> <li>• Universal eco hammock</li> </ul>	<ul style="list-style-type: none"> <li>• Standard comfort hammock</li> <li>• Universal eco hammock</li> </ul>	<ul style="list-style-type: none"> <li>• Comfort hammock without crossing (+ headrest)</li> <li>• Standard comfort hammock</li> <li>• Universal eco hammock</li> </ul>	<ul style="list-style-type: none"> <li>• Bath hammock without crossing (+ headrest)</li> <li>• Standard bath hammock</li> <li>• Universal eco hammock</li> </ul>	/
Convulsive hypertonic		<ul style="list-style-type: none"> <li>• Comfort hammock without crossing</li> </ul>	/	<ul style="list-style-type: none"> <li>• Comfort hammock without crossing (+ headrest)</li> </ul>	<ul style="list-style-type: none"> <li>• Bath hammock without crossing (+ headrest)</li> </ul>	/
Person in a shell wheelchair		<ul style="list-style-type: none"> <li>• Backrest sling</li> <li>• Quick toilet sling</li> <li>• Backrest toilet sling</li> </ul>	/	<ul style="list-style-type: none"> <li>• Backrest sling</li> </ul>	<ul style="list-style-type: none"> <li>• Backrest sling</li> </ul>	<ul style="list-style-type: none"> <li>• Backrest sling</li> </ul>
Bariatric patient		<ul style="list-style-type: none"> <li>• Bariatric sling</li> </ul>	/	<ul style="list-style-type: none"> <li>• Bariatric sling</li> </ul>	<ul style="list-style-type: none"> <li>• Bariatric sling</li> </ul>	<ul style="list-style-type: none"> <li>• Bariatric sling</li> </ul>
Agitated patient		<ul style="list-style-type: none"> <li>• Enveloping sling</li> <li>• Ergonomic sling</li> <li>• Universal eco hammock</li> </ul>	<ul style="list-style-type: none"> <li>• Universal eco hammock</li> </ul>	<ul style="list-style-type: none"> <li>• Enveloping sling</li> <li>• Ergonomic sling</li> <li>• Universal eco hammock</li> </ul>	<ul style="list-style-type: none"> <li>• Fast adjustable bath sling - for 2-point spreader bar</li> <li>• Universal eco hammock</li> </ul>	/
Postoperative phase of hip prosthesis replacement		<ul style="list-style-type: none"> <li>• Backrest toilet sling</li> <li>• Quick toilet sling</li> <li>• Comfort hammock without crossing</li> </ul>	/	<ul style="list-style-type: none"> <li>• Comfort hammock without crossing</li> </ul>	<ul style="list-style-type: none"> <li>• Quick toilet sling</li> <li>• Bath hammock without crossing</li> </ul>	<ul style="list-style-type: none"> <li>• Quick toilet sling</li> </ul>
Patient with no head support		<ul style="list-style-type: none"> <li>• Comfort sling (+ headrest)</li> <li>• Fast adjustable comfort sling</li> <li>• Backrest sling</li> </ul>	<ul style="list-style-type: none"> <li>• Standard comfort hammock</li> <li>• Universal eco hammock</li> </ul>	<ul style="list-style-type: none"> <li>• Comfort sling (+ headrest)</li> <li>• Comfort hammock without crossing (+ headrest)</li> <li>• Universal eco hammock</li> </ul>	<ul style="list-style-type: none"> <li>• Bath sling (+ headrest)</li> <li>• Fast adjustable bath sling - for 2-point spreader bar</li> <li>• Universal eco hammock</li> </ul>	/
Lack of muscle tone in the lower limbs		<ul style="list-style-type: none"> <li>• Comfort sling</li> <li>• Fast adjustable comfort sling (without headrest) - for 2-point spreader bar</li> <li>• Universal eco sling (comfort)</li> </ul>	<ul style="list-style-type: none"> <li>• Standard comfort hammock</li> <li>• Universal eco hammock</li> </ul>	<ul style="list-style-type: none"> <li>• Comfort sling (+ headrest)</li> <li>• Comfort hammock without crossing (+ headrest)</li> <li>• Universal eco hammock</li> </ul>	<ul style="list-style-type: none"> <li>• Bath sling</li> <li>• Fast adjustable bath sling (without headrest) - for 2-point spreader bar</li> <li>• Fast adjustable eco sling (without headrest) - for 2-point spreader bar</li> <li>• Universal eco sling (bath)</li> </ul>	<ul style="list-style-type: none"> <li>• Quick toilet sling</li> <li>• Backrest toilet sling</li> <li>• Universal eco toilet sling</li> </ul>
Lack of muscle tone at the bust and head level		<ul style="list-style-type: none"> <li>• Comfort sling</li> <li>• Fast adjustable comfort sling (without headrest) - for 2-point spreader bar</li> <li>• Universal eco sling (comfort)</li> </ul>	<ul style="list-style-type: none"> <li>• Standard comfort hammock</li> <li>• Universal eco hammock</li> </ul>	<ul style="list-style-type: none"> <li>• Comfort sling (+ headrest)</li> <li>• Comfort hammock without crossing (+ headrest)</li> <li>• Universal eco hammock</li> </ul>	<ul style="list-style-type: none"> <li>• Bath sling</li> <li>• Fast adjustable bath sling (without headrest) - for 2-point spreader bar</li> <li>• Fast adjustable eco sling (without headrest) - for 2-point spreader bar</li> <li>• Universal eco sling(bath)</li> </ul>	<ul style="list-style-type: none"> <li>• Quick toilet sling</li> <li>• Backrest toilet sling</li> <li>• Universal eco toilet sling</li> </ul>
Hemiplegia		<ul style="list-style-type: none"> <li>• Comfort sling</li> <li>• Fast adjustable comfort sling (without headrest) - for 2-point spreader bar</li> <li>• Universal eco sling (comfort)</li> </ul>	<ul style="list-style-type: none"> <li>• Standard comfort hammock</li> <li>• Universal eco hammock</li> </ul>	<ul style="list-style-type: none"> <li>• Comfort sling (+ headrest)</li> <li>• Comfort hammock without crossing (+ headrest)</li> <li>• Universal eco hammock</li> </ul>	<ul style="list-style-type: none"> <li>• Bath sling</li> <li>• Fast adjustable bath sling (without headrest) - for 2-point spreader bar</li> <li>• Fast adjustable eco sling (without headrest) - for 2-point spreader bar</li> <li>• Universal eco sling(bath)</li> </ul>	<ul style="list-style-type: none"> <li>• Quick toilet sling</li> <li>• Backrest toilet sling</li> <li>• Universal eco toilet sling</li> </ul>
Active paraplegia with muscle tone at the bust level		<ul style="list-style-type: none"> <li>• Backrest sling</li> <li>• Universal eco sling (comfort)</li> </ul>	/	<ul style="list-style-type: none"> <li>• Comfort sling (+ headrest)</li> <li>• Comfort hammock without crossing (+ headrest)</li> <li>• Universal eco hammock</li> </ul>	<ul style="list-style-type: none"> <li>• Bath sling</li> <li>• Universal eco sling(bath)</li> </ul>	<ul style="list-style-type: none"> <li>• Quick toilet sling</li> <li>• Backrest toilet sling</li> <li>• Universal eco toilet sling</li> </ul>
Active paraplegia without muscle tone at the bust level		<ul style="list-style-type: none"> <li>• Comfort sling</li> <li>• Fast adjustable comfort sling (without headrest) - for 2-point spreader bar</li> <li>• Universal eco sling (comfort)</li> </ul>	/	<ul style="list-style-type: none"> <li>• Comfort sling (+ headrest)</li> <li>• Comfort hammock without crossing (+ headrest)</li> <li>• Universal eco hammock</li> </ul>	<ul style="list-style-type: none"> <li>• Bath sling</li> <li>• Fast adjustable bath sling (without headrest) - for 2-point spreader bar</li> <li>• Fast adjustable eco sling (without headrest) - for 2-point spreader bar</li> <li>• Universal eco sling(bath)</li> </ul>	<ul style="list-style-type: none"> <li>• Quick toilet sling</li> <li>• Backrest toilet sling</li> <li>• Universal eco toilet sling</li> </ul>
Tetraplegia		<ul style="list-style-type: none"> <li>• Comfort sling (+ headrest)</li> <li>• Fast adjustable comfort sling</li> <li>• Backrest sling</li> </ul>	<ul style="list-style-type: none"> <li>• Standard comfort hammock</li> <li>• Universal eco hammock</li> </ul>	<ul style="list-style-type: none"> <li>• Comfort sling (+ headrest)</li> <li>• Comfort hammock without crossing (+ headrest)</li> <li>• Universal eco hammock</li> </ul>	<ul style="list-style-type: none"> <li>• Bath sling (+ headrest)</li> <li>• Fast adjustable bath sling - for 2-point spreader bar</li> <li>• Universal eco sling(bath)</li> </ul>	/
Physical and psychical dependency		<ul style="list-style-type: none"> <li>• Enveloping sling</li> <li>• Ergonomic sling</li> <li>• Universal eco hammock</li> </ul>	<ul style="list-style-type: none"> <li>• Universal eco hammock</li> </ul>	<ul style="list-style-type: none"> <li>• Enveloping sling</li> <li>• Ergonomic sling</li> <li>• Universal eco hammock</li> </ul>	<ul style="list-style-type: none"> <li>• Fast adjustable bath sling - for 2-point spreader bar</li> <li>• Universal eco sling(bath)</li> </ul>	/

# Slings Use

Weight / Size	1m50	1m55	1m60	1m65	1m70	1m75	1m80	1m85	1m90	+ 1m90
40 kg	S	S	S	S	S	S	M	M	M	M
45 kg	S	S	S	S	S	S	M	M	M	M
50 kg	S	S	S	S	S	S	M	M	M	M
55 kg	S	S	S	S	S	S	M	M	M	M
60 kg	M	M	M	S	S	S	M	M	M	M
65 kg	M	M	M	S	S	S	M	M	M	M
70 kg	M	M	M	M	M	M	M	M	M	M
75 kg	L	L	M	M	M	M	M	M	M	M
80 kg	L	L	L	L	M	M	M	M	M	M
85 kg	L	L	L	L	M	M	M	M	M	M
90 kg	L	L	L	L	L	L	M	M	M	M
95 kg	XL	XL	XL	XL	L	L	M	M	M	M
100 kg	XL	XL	XL	XL	L	L	L	L	L	L
110 kg	XL	XL	XL	XL	L	L	L	L	L	L
120 kg	XL	XL	XL	XL	XL	XL	L	L	L	L
130 kg	XL	XL	XL	XL	XL	XL	XL	XL	XL	XL
more than 130 kg	XL+	XL+	XL+	XL+	XL+	XL+	XL+	XL+	XL+	XL+



## Reuse

The patient hoist is suitable for reuse. Ensure that the patient hoist has been cleaned according to Chapter Care / Cleaning and serviced according to Chapter Maintenance before the reuse.

## Labelling

Labelling on the box

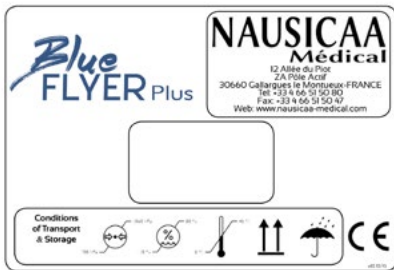

# Labelling



## SAFETY INSTRUCTIONS BEFORE EACH USE

**NAUSICAA**  
Medical

1

- Check the perfect condition of the hoist sling.
- Check the perfect condition of the traction sling (EASYLEV, NAUSILEV).
- Verify the presence and conditions of safety devices: all axis and their constrained fixations (pins, clips and bolts) and the tightness of the screws (see user manual).

DO NOT USE THE DEVICE IN CASE OF ANY LACK OR BAD OVERALL STATE

**Blue**  
**FLYER** Plus

**NAUSICAA**  
Médical

2

POIDS MAXIMUM  
MAXIMUM WEIGHT  
MAXIMALE TRAGFÄHIGKEIT  
PESO MAXIMO  
PESO MASSIMO

**180 kg**

CE **NAUSICAA** FRANCE  
Médical v.02.12-15

3



## BATTERY MAINTENANCE

**NAUSICAA**  
Medical

A POORLY MAINTAINED BATTERY DETERIORATES

- Regularly recharge the battery at the maximum.
- Making small incomplete charges shortens the battery life.
- The battery should not be exposed to temperatures neither too low nor too high.
- The batteries status depends on the maintenance and therefore can not be under warranty.
- It is important to check the charger if the battery no longer works.

4

**BLUE**  
**FLYER** CE

NAUSICAA MEDICAL  
11 Avenue de la République  
91000 Evry-Courcouronnes  
France

BFLP-0001-FM



Année/Mois de Fabrication: \_\_\_\_\_ / \_\_\_\_\_

Capacité Maximale: 180 kg

5



# Labelling

---



# Preventive Maintenance & Security Controls

Patient Lift: BLUE FLYER PLUS with mechanical opening legs

Serial Number :

Control of security points (Frequency: depending on use, recommended every three months)  
This is a sight control : any wear trace must lead to a replacement.

		GOOD	WRONG	DATE OF CHANGE
1	Spreader bar fixation			
2	Actuator top fixation			
3	Mast top fixation			
4	Actuator bottom fixation			
5	Mast/Base assembly			
6	Mast/Base assembly 2			
7	Handle bar fixation			
8	Foot pedal fixation			
9	Wheels fixation			
10	Foot/base assembly			
11	Structure state			

Control of electrical functions (Frequency: depending on use, at least once a year)  
this control must be carried out when the hoist is loaded.

		GOOD	WRONG	DATE OF CHANGE
A	Operation of the actuator			
B	Operation of the emergency system			
C	Batteries status (charge holding)			
D	Handcontrol status			

Inspection carried out on :	Inspection carried out by :	Date of the next inspection :

# Preventive Maintenance & Security Controls

Control of security points (Frequency: depending on use, recommended every three months)  
This is a sight control : any wear trace must lead to a replacement.

- 1 → Spreader bar fixation
- 2 → Actuator top fixation
- 3 → Mast top fixation
- 4 → Actuator bottom fixation
- 5 → Mast/Base assembly
- 6 → Mast/Base assembly 2
- 7 → Handle bar fixation
- 8 → Foot pedal fixation
- 9 → Wheels fixation
- 10 → Foot/base assembly
- 11 → **STRUCTURE STATE**

THESE CONTROLS CAN BE CARRIED OUT WITHOUT LOAD

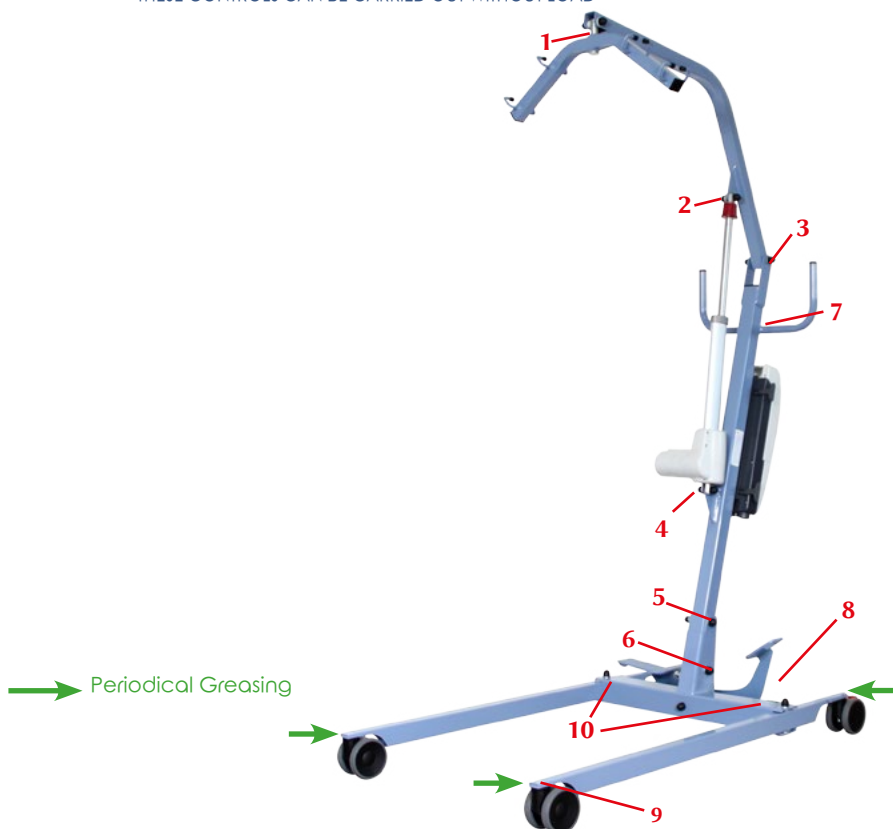

# General Safety Guidelines

---

1. Use the Patient Lift only for its intended purpose, in accordance with the legislation for medical devices, the regulations for labor protection and accident prevention, as well as the generally recognized rules of technology.
2. Note that the Patient Lift is a medical device, therefore the user is required to comply with the directive on the use of medical devices.
3. The requirements for the electrical installation of the room or area where the Patient Lift is used must meet the current state of the technology.
4. Using the Patient Lift only after being trained for its handling.
5. Before using the device, please read the complete User Manual in order to avoid damage due to improper handling or exposure to risks. The User Manual contains important information and notes required for the Patient Lift use.
6. Use the Patient Lift in accordance with this User Manual only. Keep the User Manual for future reference in case of questions. Join this User Manual to the Patient Lift in case of change of ownership.
7. Before any use, it must be ascertained whether the Patient Lift and its accessories are in working order and in impeccable conditions.
8. Before using the Patient Lift with other medical and non-medical devices, check that the combination of these products is allowed and can be used together safely.
9. Assembly, commissioning, maintenance and repair of the Patient Lift should be entrusted only to specialists.
10. It is up to the user or operator to ensure (through adequate measures and instructions) that mechanical stress of the charging cord (through bending, tension, shear, crushing) is excluded during loading or cleaning of the part. This also applies to the electrical cables of other devices used with the Patient Lift.
11. Respect the activation duration and the maximum weight capacity. These values must not be exceeded, otherwise the Patient Lift safe operation is no longer guaranteed.
12. Do not expose the Patient Lift to direct sunlight or heat.
13. Ensure that no moisture enters the electrical system.
14. Avoid mechanical stress on electrical cords. Pull, bend or crush the cords may damage them.
15. Charge batteries in a well ventilated area.
16. Electromagnetic interferences can not be excluded from the Patient Lift and other devices. If there is a risk of such interference, the source of interference must be removed or the Patient Lift should not be used.
17. Disruptions caused by the use of portable communication devices can not be completely excluded. This is why a safe distance of at least 3 meters must be kept in order to ensure the functioning of the Patient Lift safely.
18. Do not leave unattended children stand near the Patient Lift.
19. The Patient Lift should not be used as soon as abnormal noises, damages or any other malfunctions occur. In this case, do not connect the wall charger to the Patient Lift and inform us.
20. If damaged or defective, the Patient Lift should not be used and should not be connected to the direct current. Inform the dealer to remedy the default or failure.

# Technicals & Dimensionals Characteristics

- Frame made in steel
  - Laser cutting and bending sheet metal, tubes and profiles
  - Epoxy baked painting
  - Ball bearing castors
  - Total weight : 40 kg
  - Weight of the heaviest part: 5,8 kg
  - Weight capacity : 180 kg
  - Lifespan : 8 years (except electrical parts)
- \* SCP : Suspension central point



Dimensions (in mm)

- A. Total length: 1200 mm
- B. Minimum lifting height: 620 mm
- C. Maximum lifting height: 1800 mm
- D. Total height: 1350 mm
- E. Height of chassis: 113 mm
- F. Minimum base width: 650 mm
- G. Maximum base width: 1070 mm
- H. Turning diameter: 1380 mm

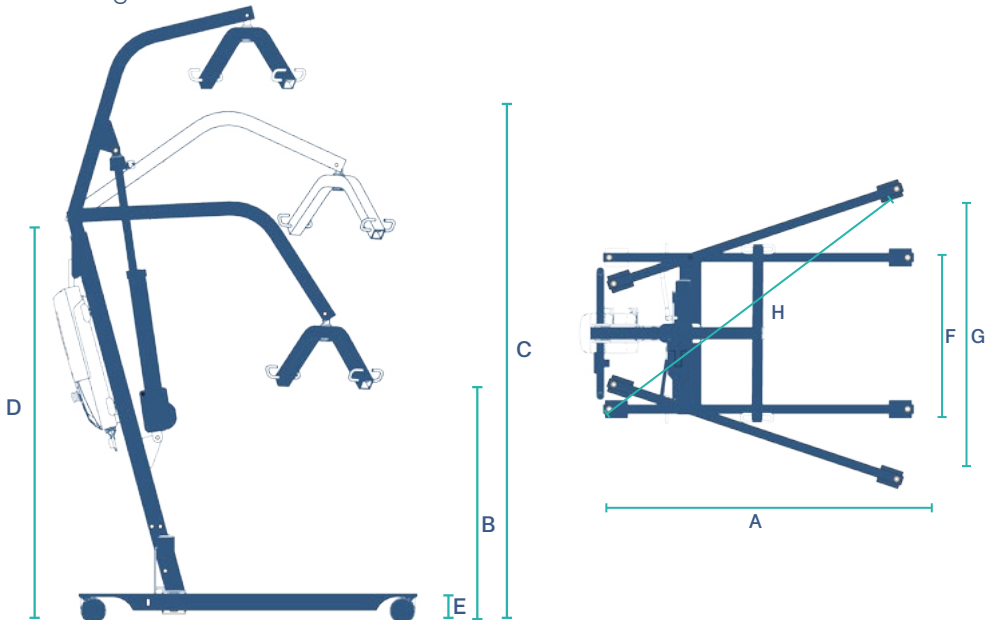

# Spare Parts

<b>BLUE FLYER PLUS</b>	
<b>FRAME</b>	
BFL-BRS	LIFTING ARM BLUE FLYER
F3-AXVF	SPREADER BAR VERTICAL AXIS
BFL-FS8P	8 POINTS SPREADER BAR
BFL-PD	RIGHT FOOT FOR BLUE FLYER
BFL-PG	LEFT FOOT FOR BLUE FLYER
BFL-MT	MAST FOR BLUE FLYER
BFL-EMB	BASE FOR BLUE FLYER
BFL-SCEP	SPREADING SYSTEM SET FOR BLUE FLYER (without foot pedal)
BFL-PDL	FOOT PEDAL FOR BLUE FLYER
BFL-KIT-EPE	ELECTRICAL OPENING BASE LEGS COMPLETE SET (3 metallic pieces,without rod, without actuator)
WP-RJNFRD100	BLACK TWIN CASTORS WITH RED BRAKE DIAMETER 100mm (ball bearing)
WP-RJND100	BLACK TWIN CASTORS DIAMETER 100mm (ball bearing)
BW-BPBP	BLUE PIGEON SPRAY PAINT
BW-VBP	BLUE PIGEON STICKER PAINT
<b>MOTORIZATION VEOBOX 3 FOR 1 ACTUATOR (mechanical opening legs)</b>	
VS-TLCM3	2 FUNCTIONS REMOTE CONTROL FOR VEOBOX 3
VS-TLCM3-CCC	CONTROL BOARD FOR 2 FUNCTIONS REMOTE CONTROL FOR VEOBOX 3
VS-TLCM3-CRD	CORD FOR 4 FUNCTIONS REMOTE CONTROL FOR VEOBOX 3
VS-AMTL	MAGNET FOR REMOTE CONTROL
VS-CRTL	REMOTE CONTROL HOOK
VS-TLCM3-FA	FRONT LABEL FOR REMOTE CONTROL 2 FUNCTIONS FOR VEOBOX 3
VS-BCAM-SMP	REMOVABLE BATTERY PACK (with 2 internal batteries 5A/12V) WITHOUT LOAD DISPLAY AND BALANCING
F3-BT2IN	SET OF 2 INTERNAL BATTERIES 5A/12V
BAT-LI	INTERNAL LITHIUM BATTERY 5A / 24V
VS-BCAM-LI	LITHIUM BATTERY PACK WITH DISPLAY
VS-BCAM-CAR	BATTERY PACK COMPLETE CASING
VS-BCAM-KCRT	2 ELECTRONIC BOARDS SET (display and balancing) FOR BATTERY PACK VS-BCAM
VS-BCAM-KCFC	CONNECTION KIT WITH FUSES FOR BATTERY PACK VS-BCAM OU VS-BCAM-SMP
FUS-5-20-200MA	INTERNAL DELAY FUSE 5X20-200MA (set of 5)
FUS-5-20-1A	INTERNAL DELAY FUSE 5 x 20-1A 250 v (set of 5)
VS-BCAM-FAE	BATTERY PACK ADHESIVE FRONTAGE DISPLAY FOR VS-BCAM
VS-BCAM-CR	BATTERY PACK HOOK FASTENING
VS-BCC3	CONTROL BOX VEOBOX 3 2 FUNCTIONS (without battery pack)
VS-BCC3-CCC	CONTROL BOARD FOR VEOBOX 3 2 FUNCTIONS
VS-BCC3-BA	CONTROL BOARD WITH DISPLAY FOR VEOBOX 3 2 FUNCTIONS
VS-KCNF	CONNECTION KIT WITH FUSES FOR CONTROL BOARD VS-BCC-CCC AND VS-BCC-CCC-ECP
VS-BAUR	COMPLETE EMERGENCY STOP BUTTON
VS-BCH	CONTROL BOX POWER CORD INPUT PLUG
VS-CRD	POWER CORD
VS-ERL	POWER CORD REWINDER HOOK (set of 2)
VSVRN-F58	8000N LIFTING ACTUATOR LIFTING STROKE 290mm
VS-VRN-CHT	HEAD SCREED FOR ACTUATOR WITH EMERGENCY LOWERING SYSTEM (all models)
VS-VRN-8-CEMB	8000N LIFTING ACTUATOR BASE SCREED (all models)
VS-VRN-8-CAR	8000N (all models) AND 3000N (VSNLV-VRN) LIFTING ACTUATORS COMPLETE CASING
VS-VRN-KBPR	EMERGENCY LOWERING SYSTEM 2 RED BUTTONS SET (all models)
VS-VRN-DM-CAR	COMPLETE CONTINUED EMERGENCY LOWERING SYSTEM CASING FOR ACTUATOR (all models)
VS-VRN-DMC	COMPLETE CONTINUED EMERGENCY LOWERING SYSTEM FOR ACTUATOR (without the screed)
VS-VRN-6-8-CRD	6000N AND 8000N LIFTING ACTUATORS CORD (all models)
VS-CMB	WALL CHARGER FOR BATTERY PACK

# Cleaning & Maintenance

---

## BEFORE ANY HANDLING:

- Disconnect the AC power cord.
- Check that all electrical components are connected to each other.
- Clean electrical enclosures of the actuators and of the handsets, if they have been soiled by body fluids, especially urine.

## OBJECTIVE:

- Repair the patient lift and prevent the transmission of germs from one patient to another.
- Remove any organic soil by mechanical action (cleansing) or chemical action (disinfection).

## CLEANING PROCESS:

- Clean the surfaces with a wet cloth by using an appropriate detergent.
- A regular cleaning is recommended.

## WARNING:

- The detergents used must have a neutral pH.
- Avoid the abrasive products and solvent, they could damage the device surface state.

## DAILY MAINTENANCE:

- By means of a product applied on the surface in one operation.
- After the patient's discharge by respecting the following operation:
  - Cleaning is carried out by means of a cloth impregnated with a disinfectant solution surface.
- Maintenance by specific service providers after removal of the stand-up lift from the facility:
  - Biological cleaning operation
  - Steam cleaning of various flat surfaces. Change surfaces regularly when washing to avoid water load. Steam cleaning of inaccessible areas. For tubes, steam use with a microfiber mop. Do not direct steam directly on the electrical boxes.

## CAUTION:

- Disinfection of actuators, electrical boxes and handsets with a microfiber cloth impregnated with disinfectant.

## MONTHLY MAINTENANCE:

- Check that the device does not present any visible damages.
- Check that no part is missing.
- Check the good functioning of the castors and that no matter prevents their bearing.
- Check the good functioning of the commands as well as the connections of the remote control and the actuator on the battery.
- Clean the sockets and the commands buttons with a dry cloth, if needed with a wet cloth.
- Check the good state of the electric cables.

Never clean the patient lift, especially the electrical system, with a high pressure cleaner, water hose or similar because doing so could damage the surfaces and seals, and water could enter.

# Motorisation Technicals Characteristics

- Removable battery pack
- Digital display of the autonomy
- Emergency stop
- Electrical security lowering system
- Wall charger (in option)
- Remote control 2 functions
- Conform to Standard EN 60601-1
- DC motor low voltage 24V
- 24V / 120VA power
- Maximum strength : 8000 N
- Lifting stroke : 29 cm
- Electronic protection when overloaded
- Protection class : II
- Protections types :
  - Remote control: IP54
  - Control box: IP65
  - Battery pack: IP65
  - Actuator: IP55
- Stop limit switch
- Box in ABS
- Handcontrol with spiral cable, low voltage 24V
- Protection against overloading through thermo-switch
- Loudness : less than 55dB at a distance of 1 meter.
- Electromagnetic compatibility : conforms to EN 60601-1-2



## Battery Charging Diagram :

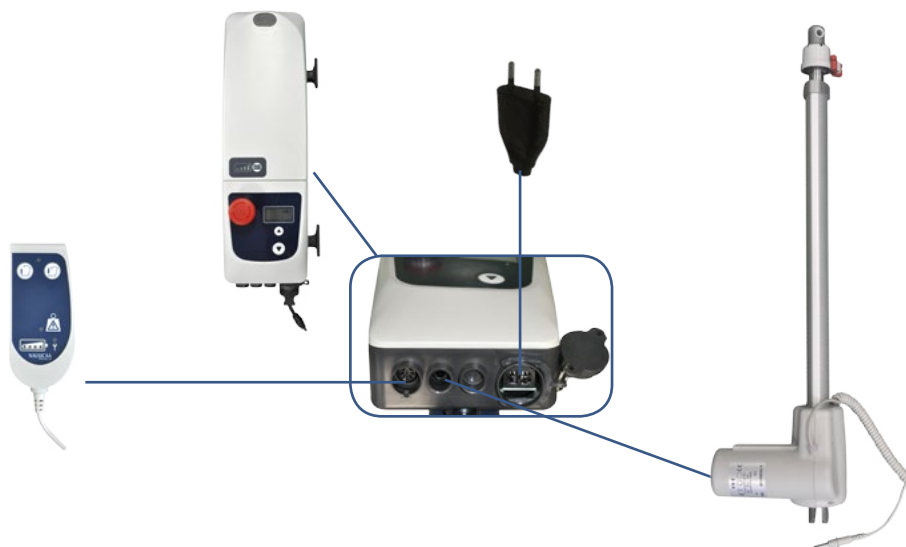



# Motorisation Technicals Characteristics

## A. LCM DISPLAY

### 0. Information display

- To view the information registered in the control box, you must press the up and down buttons of the box for 5 seconds.

### 1. Operating factor

- Definition: It accounts for the actuator (up / down) any breach of the duty cycle = non-respect of the actuator rest.



### 2. Overloading of the actuator / a

- It counts the number of times an attempt to lift a person weighing beyond the maximum weight limit is performed. When it occurs, the actuator will stop and an anvil will appear, it will be impossible to continue.



### 3. Overloading of the actuator / b

- It counts the number of times an attempt to spread or close the opening legs while they are stuck is performed. When it occurs, the actuator will stop and an anvil will appear, it will be impossible to continue.



### 4. Incomplete load

- It records all incomplete loads below 24,6V. This corresponds to the number of charges damaging the battery.



### 5. Time of use

- Definition: It displays the cumulative operating time of the device. Starting from 600,000 seconds of use, a maintenance key is displayed; it is then essential to carry out a complete control of the device.



# Troubleshooting Guide

Problem	Origin	Solutions
The product, without patient, does not go down.	Our products need some weight to go down.	Push down on the lifting arm while pushing the lowering button on the remote control.
Mobile parts are too hard, product is difficult to handle.	Mobile parts need to be greased.	Grease the mobile parts.
The actuator does not work but the user can hear a "click" in the control box when the remote control button is pushed.	<ol style="list-style-type: none"> <li>1. Batteries are unloaded.</li> <li>2. The actuator jack is not plugged.</li> <li>3. The actuator jack is deteriorated.</li> <li>4. There are damages on the actuator or on the control box.</li> </ol>	<ol style="list-style-type: none"> <li>1. Load the device.</li> <li>2. Plug the actuator jack.</li> <li>3. The actuator has to be repaired.</li> <li>4. The entire electric system has to be checked.</li> </ol>
The actuator does not work and the user does not hear a "click" in the control box when the remote control button is pushed.	<ol style="list-style-type: none"> <li>1. Emergency button is activated.</li> <li>2. There is no contact between the battery and the control box.</li> <li>3. Batteries are unloaded.</li> <li>4. The remote control jack is not plugged.</li> <li>5. The remote control jack is deteriorated.</li> <li>6. There are damages on the remote control or on the control box.</li> </ol>	<ol style="list-style-type: none"> <li>1. Turn the button to unlock the device.</li> <li>2. Take off the battery and put it back.</li> <li>3. Check the charging cord.</li> <li>4. Plug the remote control.</li> <li>5. Change the remote control.</li> <li>6. The entire electric system has to be checked.</li> </ol>
The actuator stops when lifting.	<ol style="list-style-type: none"> <li>1. Batteries are unloaded (sound system + "low battery" written on the screen).</li> <li>2. The product has been used for too long.</li> <li>3. The weight lifted is too heavy.</li> </ol>	<ol style="list-style-type: none"> <li>1. Check the charging cord then load battery.</li> <li>2. Let the device rest a moment (as a protection for the actuator lifespan).</li> <li>3. Reduce the weight lifted.</li> </ol>
The actuator does not work at all	<ol style="list-style-type: none"> <li>1. The control box is broken down.</li> <li>2. The remote control is broken down.</li> </ol>	<ol style="list-style-type: none"> <li>1. The control box has to be changed.</li> <li>2. The remote control has to be changed.</li> </ol>

# Warranty

---

- Article 1 : NAUSICAA Médical S.A.S. warrants this product against any defects in manufacturing and assembly of mechanical and electronic components. This warranty is for devices used only in accordance with NAUSICAA Médical S.A.S. terms of use. The warranty covers all mechanical and electrical parts, except battery and breakage. This warranty whose terms of use are defined below is valid for 60 months from the date of first departure from NAUSICAA Médical S.A.S.
- Article 2 : The warranty entitles the free labor and the free replacement of defective parts.
- Article 3 : The original out-going shipping costs of the device and all associated costs are the responsibility of the distributor. The goods always travel at the risk and the responsibility of the distributor.  
Under warranty : return costs after intervention will be borne by NAUSICAA Médical S.A.S.  
Out of warranty: return costs are at the expense of the distributor whether or not he accepts the repair estimate.
- Article 4 : The warranty does not apply if the claims are consecutive to:
  - accident, misuse or neglect of the unit by the end customer.
  - shipping performed without adequate protection.
  - alteration or transformation not validated by NAUSICAA Médical S.A.S.
  - the impact of external elements (natural disaster, fire, shock, humidity, flood, lightning, ...).
  - installation and/or use in a non-compliant way with technical standards and safety (in case the unit would work in a country other than the country of origin) ; and/or if the electrical power is not suited for the operating voltage of the device.
  - a lack of routine maintenance.
- Article 5 : The distributor may not invoke the benefit of the warranty:
  - if the device serial number has been removed, altered or rendered illegible.
  - if the device under warranty has been modified without the approval of NAUSICAA Médical S.A.S.
- Article 6 : During the repair of any defective equipment, no loan will be made.
- Article 7 : All warranty claims must be exercised through the distributor.
- Article 8 : Sending spare parts under warranty will be made after consultation with the distributor customer service.
- Article 9 : Defective parts changed under or out of warranty will be guaranteed for 6 months from the date of repair or sending of the spare parts.
- Article 10 : No distributor can unilaterally change the terms of this warranty.

# NAUSICAA Medical

## CONTACT

Phone: +33 (0) 466 717 184

Fax: +33 (0) 466 532 305

Email: [export@nausicaa-medical.com](mailto:export@nausicaa-medical.com)

Website: [www.nausicaa-medical.eu](http://www.nausicaa-medical.eu)

Manufactured by NAUSICAA Médical S.A.S.



**NAUSICAA**  
Medical

12 Allée du Plot - ZA Pôle Actif  
30660 Gallargues le Montueux  
FRANCE